

CONDIZIONI GENERALI DI VENDITA

1 - Gli ordini devono essere trasmessi per iscritto. 2 - I termini di consegna, anche se riferiti ad una data, si intendono approssimativi salvo espressa pattuizione scritta. 3 - Interruzioni forzate di produzione, come pure quelle dei principali fornitori, esonerano la venditrice per la corrispondente durata. 4 - I prezzi di listino non sono impegnativi, verranno tuttavia comunicate eventuali modifiche al più tardi al ricevimento dell'ordine. 5 - Il conferimento di un ordine presuppone l'accettazione delle presenti condizioni. 6 - La merce viaggia a rischio e pericolo del committente anche se venduta franco destino. 7 - Eventuali reclami devono essere fatti entro quindici giorni dalla data di spedizione della merce. 8 - Le restituzioni saranno accettate, previa autorizzazione, in porto franco nostro stabilimento. 9 - La merce venduta rimane di proprietà della venditrice sino ad integrale pagamento. 10 - Il pagamento dovrà essere effettuato presso il domicilio della venditrice. 11 - In caso di ritardato pagamento la venditrice ha diritto di addebitare all'acquirente gli interessi di mora al tasso annuo bancario vigente su scoperti di C/C maggiorato del 4% anche per pagamenti convenuti a mezzo obbligazioni cambiarie; ha pure il diritto di sospendere le consegne e di annullare i contratti già in corso. 12 - Per qualsiasi controversia si adirà l'Autorità Giudiziaria competente nel territorio della venditrice.

GENERAL TERMS OF TRADE

1 - Orders must be passed in writing. 2 - Delivery terms, even if referring to a certain date, are to be considered approximate, unless a special written agreement is made. 3 - Forced interruptions of production, as well as interruptions by main suppliers, free the seller from delivery engagement for the duration of the above mentioned interruptions. 4 - List prices are not binding, however modifications, if any, will be communicated on receipt of order, at the latest. 5 - Passing an order implies the acceptance of these conditions. 6 - The goods travel at the buyer's risk even if they are sold free delivered unless referring to the INCOTERMS. 7 - All claims are to be made within 15 days from date of shipment of goods. 8 - Returns will be accepted, by authority received, free of carriage at our factory. 9 - The goods sold are still owned by the seller until full payment is effected. 10 - Payment is to be effected at seller's domicile. 11 - In case of delayed payment the seller will have the right of charging the purchaser with interests on delayed payment at the annual bank rate in force in Italy on overdrawn current accounts plus 4% also for payments agreed by means of bill of exchange bonds; the seller also has the right of stopping deliveries and cancelling contracts already outstanding. 12 - In case of any controversy, legal steps will be taken through the law Court governing in the seller's territory.

ALLGEMEINE VERKAUFSBEDINGUNGEN

1 - Die Bestellungen müssen schriftlich durchgegeben werden. 2 - Die Liefertermine, auch bei festgelegtem Datum, müssen schriftlich vereinbart werden. 3 - Zwangsläufige Produktionseinstellung der Lieferfirma oder deren Lieferanten entbindet von jeder Lieferverpflichtung. 4 - Die Listenpreise sind nicht verpflichtend; eventuelle Änderungen werden jedoch spätestens bei Auftragseingang bekannt gegeben. 5 - Die Auftragserteilung setzt voraus, dass vorliegende Lieferbedingungen angenommen wurden. 6 - Der Transport geht auf Risiko und Verantwortung des Auftraggebers, auch bei Lieferungen frei Bestimmungsort, es sei denn, man bezieht sich auf die INCOTERMS. 7 - Eventuelle Beanstandungen müssen innerhalb von 15 Tagen ab Lieferdatum der Ware vorgebracht werden. 8 - Die Zurückerstellungen werden, nach vorheriger Genehmigung, frei unser Werk angenommen. 9 - Die verkaufte Ware bleibt bis zur vollständigen Bezahlung Eigentum der Lieferfirma. 10 - Die Zahlung muss an den der Lieferfirma erfolgen. 11 - Bei Zahlungsverzögerungen hat die Lieferfirma das Recht, dem Käufer die Verzugszinsen zum jeweils gültigen, offiziellen Bankzinskurs für ungedeckte laufende Rechnungen plus 4% auch für Wechselschuldverschreibungen aufzuschlagen; ebenso ist er berechtigt, die Lieferungen einzustellen und laufende Verträge zu kündigen. 12 - Im Falle von Kontroversen ist der kompetente Gerichtshof der Lieferfirma zuständig.

CONDITIONS GENERALES DE VENTE

1 - Les commandes doivent être passées par écrit. 2 - Les délais de livraison, même en cas de date fixée, sont approximatifs, sauf en cas d'accord confirmé par écrit. 3 - En cas d'interruption de la production pour causes de force majeure, ou de manque de livraison de la part des principaux fournisseurs, le vendeur ne sera pas tenu au respect des délais de livraison fixés. 4 - Les prix indiqués dans le tarif n'engagent pas le vendeur; d'éventuelles modifications seront cependant communiquées au plus tard dès réception de la commande. 5 - Toute commande est soumise à l'acceptation des présentes conditions. 6 - La marchandise voyage aux risques et périls de l'acheteur, même en cas de vente franco destination, sauf pour les INCOTERMS. 7 - D'éventuelles réclamations devront parvenir dans les 15 (quinze) jours suivant l'envoi de la marchandise. 8 - Les retours seront acceptés, moyennant autorisation préalable, franco notre établissement. 9 - La marchandise vendue reste propriété du vendeur jusqu'à son règlement total. 10 - Le règlement devra être effectué au domicile du vendeur. 11 - En cas de retard dans le règlement, le vendeur a le droit de débiteur à l'acheteur les intérêts de retard au taux annuel bancaire en vigueur sur le découvert en compte courant, majoré de 4%, même sur des règlement stipulés au moyen d'obligations de change; le vendeur se réserve le droit de suspendre les livraisons et d'annuler les contrats déjà en cours. 12 - Pour tout litige, le tribunal compétent est celui du domicile du vendeur.

Nomi e numeri delle Case costruttrici sono usati solo come riferimento. I disegni sono puramente indicativi. La riproduzione del contenuto del presente catalogo, in toto o in parte, inclusi numeri, fotografie, disegni e impostazione grafica é severamente vietata.

Si declina comunque ogni responsabilità per eventuali errori e/o omissioni in esso contenuti.

The names and numbers of manufacturers are used for reference purposes only. Drawings are purely illustrative. Reproduction of any part of the information contained herein, including numbers, pictures, drawings and graphic layout is strictly forbidden.

We decline responsibility for any errors or omissions herein.

Namen und Nummern von Herstellern werden nur als Bezugspunkt verwendet. Die Zeichnungen sind rein informativ.

Die Teilweise der vollständige Vervielfältigung des vorliegenden Katalogs, inklusive Nummern, Zeichnungen, Photographien und graphische Darstellungen ist streng verboten.

Man lehnt jede Verantwortung für eventuelle Fehler oder Auslassungen ab.

Les noms et codes des constructeurs ne sont utilisés que comme référence. Les dessins ne sont qu'indicatifs.

La reproduction totale ou partielle du contenu de ce catalogue, y compris les nombres, photographies, dessins et mise en page es sévèrement interdite.

Nous déclinons toute responsabilité pour d'éventuelles erreurs et omissions.

QUALITA' DELLE SPAZZOLE

SPAZZOLE IN ELETTROGRAFITE (EG)

Sono preparate come le spazzole in carbone amorfo e trattate con temperature superiori ai 2500° C allo scopo di trasformare il carbone amorfo di base in grafite artificiale.

Le spazzole in elettrografite possiedono perfetta facoltà di commutazione, resistenza ai corti circuiti e all'usura elevata.

APPLICAZIONE:

Motori in corrente continua e corrente alternata, motori trifase, motori trazione, convertitori a fase rotante, saldatrici ad arco, motori universali.

SPAZZOLE IN METALGRAFITE (MG)

Questo tipo di spazzole é ottenuto dalla miscela base di grafite e carbone con polvere di rame ed altri metalli.

In rapporto ad altre, queste spazzole hanno una conducibilità superiore e una resistenza di contatto maggiore. La densità di corrente é nettamente superiore a quella delle spazzole in carbone puro.

APPLICAZIONE:

Spazzole di messa a terra (vetture automotrici), macchine in corrente continua a basso voltaggio, tensioni deboli o molto deboli, motori sincronizzati e asincronizzati, starters.

DIMENSIONI DELLE SPAZZOLE

T = direzione di circonferenza o larghezza

A = direzione assiale o lunghezza

R = direzione radiale o altezza

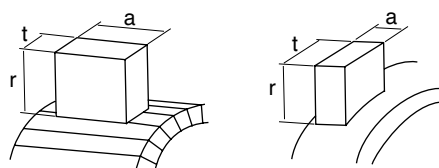

Le seguenti dimensioni e le tolleranze corrispondono alle norme DIN-CEI 43000.

1	Abeko
2	Advance
3	Allis
4	Almocar
5	Asea
6	Atlet
7	BKS
8	Bosch
9	BT
10	Carer
11	Carr-Effe
12	Carrellificio Vicentino
13	Cesab
14	CFR
15	Clark
17	Clecc
18	Climax
19	Coframa
20	Cushman
21	Deca
22	Detas
23	Etwo
24	Fein
25	Fenwick
28	Hesselmann
29	Hitachi
30	Hyster
31	Icem
32	Iron
33	Jungheinrich
35	Kalmar

36	Kentruck
37	Komatsu
38	Lansing
40	Leroy-Somer
41	Linde
42	Lugli
43	Miag
44	Mic
45	Mitsubishi
46	Nissan
47	NYK
48	Ohrstein & Koppel
49	OM
50	Ormic
51	Peg
52	Pimespo
53	Poes
54	Rolla
55	Salew
56	Samag
57	Saxby
58	Sig
59	Steinbock
60	Still
63	TCM
64	Toyota
65	Volvo
66	Wagner
68	Yale

CODICE PEDOL	CODICE ORIGINALE	DIMENSIONI T x A x R	POS.	DISEGNI DI RIFERIMENTO
--------------	------------------	----------------------	------	------------------------

08000	12521*	06.00-22.00-22.50	1	
08001	305314*	07.93-19.05-22.20	2	
08002	305414*	09.00-13.00-25.00	3	
08003	M14901*	09.00-13.00-25.00	4	
15030	M14901+	09.00-13.00-25.00	4	

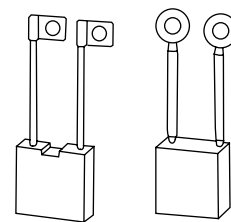

1

2

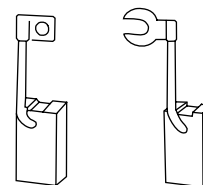

3

4

CODICE PEDOL	CODICE ORIGINALE	DIMENSIONI T x A x R	POS.	DISEGNI DI RIFERIMENTO
-----------------	---------------------	-------------------------	------	---------------------------

08004	448729+	09.52-20.72-30.00	1	
-------	---------	-------------------	---	--

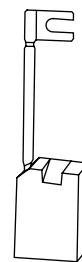

1

CODICE PEDOL	CODICE ORIGINALE	DIMENSIONI T x A x R	POS.	DISEGNI DI RIFERIMENTO
--------------	------------------	----------------------	------	------------------------

08005	+	10.00-35.00-50.00	1	 
08006	+	12.50-40.00-40.00	2	

1

2

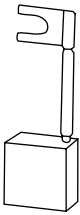
CODICE PEDOL	CODICE ORIGINALE	DIMENSIONI T x A x R	POS.	DISEGNI DI RIFERIMENTO
08007	*	08.00-16.00-22.00	1	
08008	427*	08.00-20.00-22.00	1	

1

CODICE PEDOL	CODICE ORIGINALE	DIMENSIONI T x A x R	POS.	DISEGNI DI RIFERIMENTO
08009	+	06.30-40.00-36.00	1	
08010	4391158E*	07.52-22.22-22.50	2	
15031	4391158E+	07.52-22.22-22.50	2	
08011	4391158E*	07.54-22.22-22.50	2	
08012	4391158M+	07.54-22.22-26.19	3	
08013	4391158S*	07.93-22.22-32.00	4	
08014	4391158Z+	09.50-12.70-25.40	5	
08015	4391158P+	09.52-31.75-27.00	6	
08016	4391158X+	10.00-10.00-25.00	4	
08017	43910718-024+	10.00-16.00-32.00	7	
08018	4591158-X*	10.00-20.00-25.00	8	
08019	43918212-045+	10.00-25.00-32.00	9	
08020	4391158N+	11.11-25.40-25.40	6	
08021	4391158A+	12.50-25.00-40.00	10	
08022	43918312-166+	12.50-40.00-40.00	11	
08023	4391158-AD/AC+	16.00-25.00-32.00	12	
08024	4391001-67D*	16.00-25.00-35.00	8	
08025	4391158-B+	16.00-25.00-40.00	10	
08026	+	16.00-32.00-40.00(2)	13	
08027	43919966-012+	16.00-32.00-40.00(2)	14	
08028	43919862-008+	16.00-32.00-50.00(2)	15	
08029	43919862-009+	20.00-32.00-50.00(2)	15	
08030	43917435-357+	20.00-32.00-50.00(2)	16	
08031	43917170-457+	25.00-32.00-50.00(2)	14	

CODICE PEDOL	CODICE ORIGINALE	DIMENSIONI T x A x R	POS.	DISEGNI DI RIFERIMENTO
08032	2378*	06.00-22.00-25.50	1	
15032	2378+	06.00-22.00-25.50	1	
08033	*	06.00.-28.00-30.50	2	
15033	+	06.00-28.00-30.50	2	
08034	03046*	07.20-19.10-16.70	3	
08035	03302*	07.52-22.22-22.50	4	
15034	03302+	07.52-22.22-22.50	4	
08036	04768*	08.00-28.00-30.50	9	
15035	04768+	08.00-28.00-30.50	2	
08037	09434*	08.80-19.10-12.00	5	
08038	09633+	12.00-32.00-32.00	6	
08039	04027*	12.50-25.00-40.00	7	
08040	09570*	12.70-25.40-31.75	8	

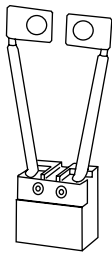
CODICE PEDOL	CODICE ORIGINALE	DIMENSIONI T x A x R	POS.	DISEGNI DI RIFERIMENTO
08041 15036	* +	10.00-26.00-30.50 10.00-26.00-30.50	1 1	

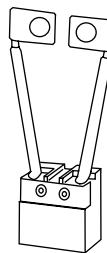

1

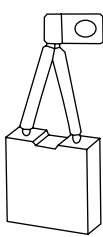
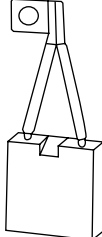
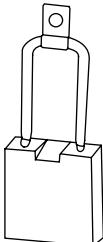
CODICE PEDOL	CODICE ORIGINALE	DIMENSIONI T x A x R	POS.	DISEGNI DI RIFERIMENTO
08042	2137014006-000*	06.00-22.00-25.00	1	
15037	2137014006-000+	06.00-22.00-25.00	1	
08043	2137014036+	08.00-25.00-32.00	2	
08044	2137014026*	08.00-28.00-30.50	3	
15038	2137014026+	08.00-28.00-30.50	2	
08045	+	08.00-28.00-33.50	1	
08046	2137014024+	10.00-26.00-31.00	2	<p style="text-align: center;">1 2</p> <p style="text-align: center;">3</p>

CODICE PEDOL	CODICE ORIGINALE	DIMENSIONI T x A x R	POS.	DISEGNI DI RIFERIMENTO
--------------	------------------	----------------------	------	------------------------

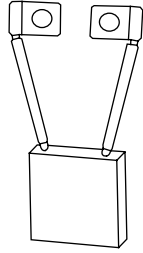
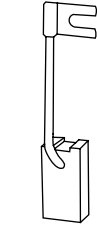
08047	50015*	06.00-28.00-30.50	1	
08048	26729+	09.00-13.00-25.50	2	
08049	50016*	09.00-13.00-25.50	3	
08050	22355*	09.00-13.00-25.50	2	
08051	21367*	09.00-13.00-25.50	2	
08052	24781*	10.00-20.00-20.00	4	
08053	20991*	10.00-20.00-20.00	5	
08053	50018*	10.00-20.00-20.00	5	
08055	+	10.00-20.00-21.00	4	
08056	26105*	10.00-20.00-25.00	5	
08056	26655*	10.00-20.00-25.00	5	
08056	27919*	10.00-20.00-25.00	5	
08059	20944*	12.50-25.00-32.00	6	
08059	50017*	12.50-25.00-32.00	6	
08061	70696+	20.00-32.00-60.00(2)	7	

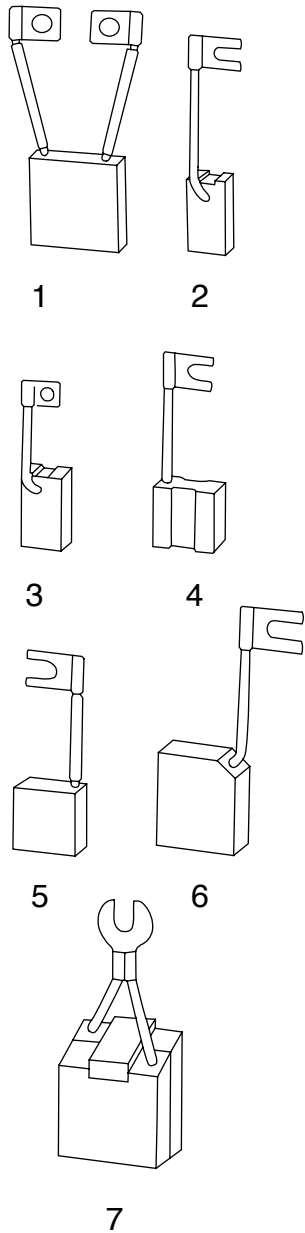

CODICE PEDOL	CODICE ORIGINALE	DIMENSIONI T x A x R	POS.	DISEGNI DI RIFERIMENTO
08604	MO1107+	08.00-16.00-20.00	5	
08600	MA1107*	10.00-26.00-30.50	1	
08601	MB1107+	10.00-30.00-25.00	2	
08603	MO2107+	12.00-20.00-32.00	4	
08602	ML1107+	15.00-20.00-30.00	3	

CODICE PEDOL	CODICE ORIGINALE	DIMENSIONI T x A x R	POS.	DISEGNI DI RIFERIMENTO
08612	*	06.00-28.00-30.50	2	
08613	*	09.00-13.00-25.50	3	
08614	*	09.00-13.00-25.50	4	
08611	*	10.00-12.50-22.50	1	

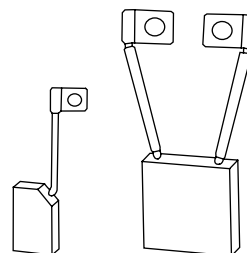

1



2



3

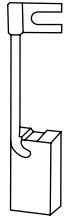

4

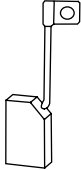
CODICE PEDOL	CODICE ORIGINALE	DIMENSIONI T x A x R	POS.	DISEGNI DI RIFERIMENTO
08623	*	09.00-13.00-25.50	1	
08624	*	09.00-13.00-25.50	2	
08625	*	10.00-12.50-22.50	3	

CODICE PEDOL	CODICE ORIGINALE	DIMENSIONI T x A x R	POS.	DISEGNI DI RIFERIMENTO
--------------	------------------	----------------------	------	------------------------

15107	0018105+	07.00-16.00-35.00(2)	4
15101	0016746+	16.00-32.00-35.00	2
15100	0016454+	16.00-37.00-35.00	1
15100	0018071+	16.00-37.00-35.00	1
15103	0018070+	16.00-40.00-35.00	3
15103	0016753+	16.00-40.00-35.00	3

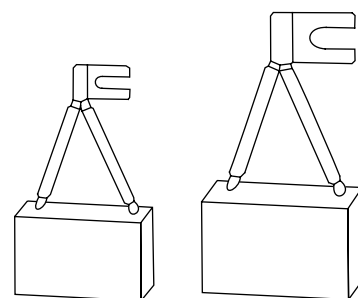

1

2

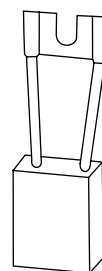

3

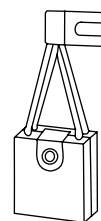

4

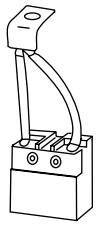
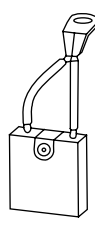
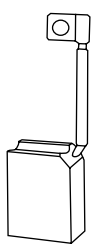
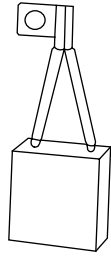
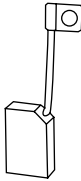
CODICE PEDOL	CODICE ORIGINALE	DIMENSIONI T x A x R	POS.	DISEGNI DI RIFERIMENTO
08062	*	06.00-22.00-25.50	1	
08054	+	06.00-22.00-25.50	1	
08063	*	06.00-22.00-25.50	2	
08057	+	06.00-22.00-25.50	2	
08064	*	08.00-22.00-28.50	3	
08058	+	08.00-22.00-28.50	3	
08065	*	08.00-32.00-32.00	4	
08060	+	08.00-32.00-32.00	4	
08066	*	10.00-12.50-22.50	5	
15039	+	10.00-12.50-22.50	5	

CODICE PEDOL	CODICE ORIGINALE	DIMENSIONI T x A x R	POS.	DISEGNI DI RIFERIMENTO
--------------	------------------	----------------------	------	------------------------

08067	1810684*	07.14-22.22-19.00	1	
08068	3737662+	07.52-22.22-26.00	2	
08069	3737662+	07.93-22.22-31.70	3	
08070	3736652+	07.93-22.22-31.75	4	
08071	3580801+	07.93-31.75-30.00	5	
08072	1811550*	08.00-12.50-22.00	6	
08082	1811550+	08.00-12.50-22.00	6	
08073	3700094*	08.00-32.00-30.00	7	
08074	+	08.00-32.00-30.00	5	
08075	*	08.00-32.00-30.50	7	
08076	1811553*	08.00-32.00-32.00	8	
08090	1811553+	08.00-32.00-32.00	8	
08077	*	08.70-19.00-13.50	9	
08078	+	09.00-12.00-30.00	7	
08079	*	09.00-16.00-19.00	10	
08080	3580672+	09.00-17.00-30.00	7	
08081	1810663+	09.00-19.00-17.00	12	
08081	1810775+	09.00-19.00-17.00	12	
08083	1810775+	09.00-19.00-17.00	12	
08084	1810488*	09.52-19.05-19.05	11	
08085	+	09.52-25.40-28.50	13	
08086	1811305*	10.00-28.00-30.50	14	
08087	1811307*	10.00-28.00-30.50	15	
08091	1811305+	10.00-28.00-30.50	14	
08088	*	10.30-19.81-31.70	16	
08089	1810651+	10.30-25.40-35.00	17	
08089	1810799+	10.30-25.40-35.00	17	
08089	1811468+	10.30-25.40-35.00	17	
08092	+	10.71-31.75-32.00	18	

CODICE PEDOL	CODICE ORIGINALE	DIMENSIONI T x A x R	POS.	DISEGNI DI RIFERIMENTO
08093	3700101*	11.90-32.10-30.00	1	
08094	3753621+	12.00-20.00-25.00	2	
08095	+	12.00-20.00-32.00	3	
08096	+	12.00-32.00-32.00	4	
08097	3559283+	12.00-32.00-32.00	2	
08097	3581242+	12.00-32.00-32.00	2	
08097	3700101+	12.00-32.00-32.00	2	
08101	+	12.00-32.00-32.50	5	
08102	*	12.30-32.14-30.00	1	
08103	3493829+	12.50-32.00-25.00	6	
08103	3559282+	12.50-32.00-25.00	6	
08105	1811546+	12.50-32.00-32.00	7	
08106	3493022*	12.70-25.40-31.70	8	
08107	3485935+	12.70-31.75-31.50	6	
08108	1810798+	13.89-25.40-35.00	9	
08109	3716093+	15.87-19.80-38.00	10	
08110	+	15.87-31.75-32.00	11	
08111	+	15.87-31.75-40.00	11	
08112	1907737+	15.87-31.75-44.50	13	
08113	+	15.87-37.70-37.70	12	
08114	+	16.00-40.00-45.00	14	

CODICE PEDOL	CODICE ORIGINALE	DIMENSIONI T x A x R	POS.	DISEGNI DI RIFERIMENTO
-----------------	---------------------	-------------------------	------	---------------------------

08115

*

12.70-31.75-32.00

1

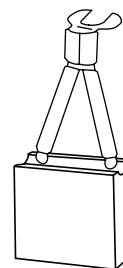

1

CODICE PEDOL	CODICE ORIGINALE	DIMENSIONI T x A x R	POS.	DISEGNI DI RIFERIMENTO
08116	66877+	06.35-12.50-22.50	1	
08117	61636*	08.00-16.00-19.00	2	
08118	+	08.00-16.00-25.00	3	
08119	+	09.50-38.10-22.20	4	
08120	+	11.10-25.40-25.40	5	
08121	+	12.70-25.40-31.75	6	
08122	6733+	12.70-31.75-30.00	7	
08123	56992+	12.70-50.00-44.50	8	

CODICE PEDOL	CODICE ORIGINALE	DIMENSIONI T x A x R	POS.	DISEGNI DI RIFERIMENTO
-----------------	---------------------	-------------------------	------	---------------------------

08124

+

12.50-32.00-32.00



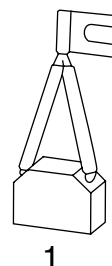

1

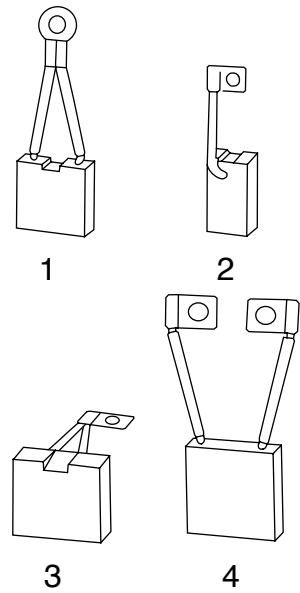

CODICE PEDOL	CODICE ORIGINALE	DIMENSIONI T x A x R	POS.	DISEGNI DI RIFERIMENTO
08125	*	12.70-16.27-28.00	1	

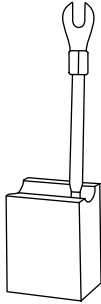
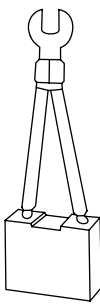
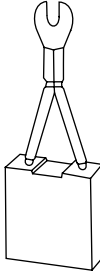
CODICE PEDOL	CODICE ORIGINALE	DIMENSIONI T x A x R	POS.	DISEGNI DI RIFERIMENTO
08648	05.02.01004*			
08649	05.02.01001*	06.00-28.00-30.50	4	
08646	05.02.01008+	09.00-13.00-25.00	2	
08647	05.02.01007*	09.00-26.00-25.50	3	
08626	+	10.00-20.00-30.00	1	
08627	05.02.01002+	10.00-26.00-30.00		

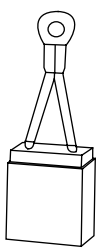

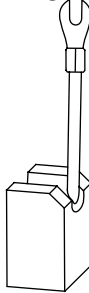
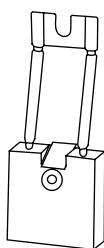
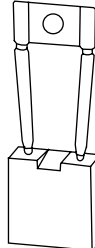
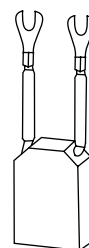
CODICE PEDOL	CODICE ORIGINALE	DIMENSIONI T x A x R	POS.	DISEGNI DI RIFERIMENTO	
08596	9275290010+	06.00-28.00-30.50	9	 	
08595	9385290020+	08.00-16.00-22.00	5		
08590	9185290030+	08.00-16.00-25.00	5		
08591	675201+	09.50-25.00-25.00	6		
08589	14000020+	10.00-20.00-26.00	4		
08597	9275290040-5-6*	10.00-26.00-30.50	10		
08594	9405290010+	12.00-20.00-30.00	8		
08599	9275290020+	12.00-20.00-30.00	11		
08592	14000010+	12.00-25.00-26.00	7		
08598	9185290020+	12.50-20.00-30.00	8		
08587	675205+	12.50-25.00-31.00	2		  
08588	675202+	12.50-32.00-32.00	3		
08593	9385290010+	15.00-20.00-32.00	8		
08586	9185290010+	16.00-25.00-45.00	1		
				  	
				  	

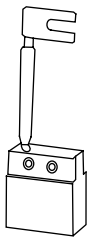
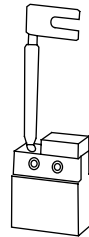
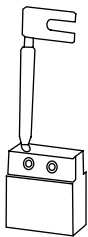
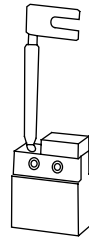
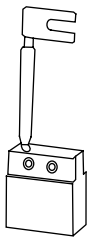
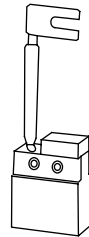
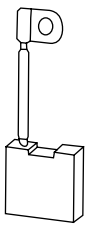
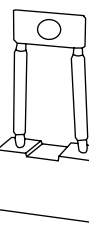
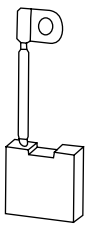
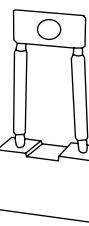
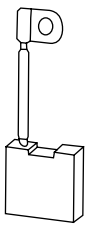
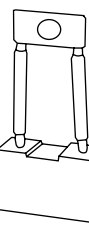
CODICE PEDOL	CODICE ORIGINALE	DIMENSIONI T x A x R	POS.	DISEGNI DI RIFERIMENTO	
08126	*	08.00-16.00-22.00	1		
08099	+	08.00-16.00-22.00	1		
08127	*	08.00-20.00-22.00	1		
08128	*	08.00-20.00-22.00	2		
08100	+	08.00-20.00-22.00	1		
08104	+	08.00-20.00-22.00	2		
08129	*	08.80-17.70-15.80	3		
15040	+	08.80-17.70-15.80	3		
08130	*	10.00-20.00-25.00	2		
15041	+	10.00-20.00-25.00	2		
08131	*	10.00-26.00-30.00	4		
15042	+	10.00-26.00-30.00	4		

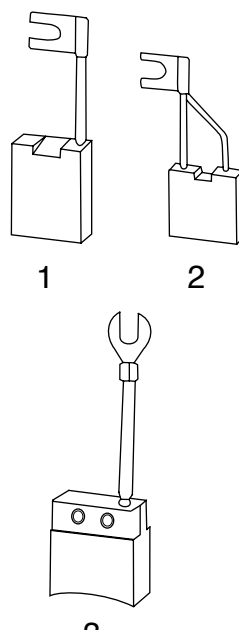
CODICE PEDOL	CODICE ORIGINALE	DIMENSIONI T x A x R	POS.	DISEGNI DI RIFERIMENTO
08132	30711093002+	07.52-22.22-22.50	1	
08133	30711092008*	07.52-22.22-22.50	2	
15043	30711092008+	07.52-22.22-22.50	2	
08134	30711058003*	25.00-10.00-32.00	3	

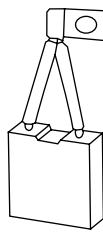
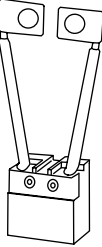
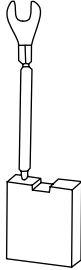
CODICE PEDOL	CODICE ORIGINALE	DIMENSIONI T x A x R	POS.	DISEGNI DI RIFERIMENTO
08135	8103846*	06.00-22.00-25.00	1	
08141	8103846+	06.00-22.00-25.00	1	
08136	8100295*	06.00-28.00-30.50	2	
08149	8100295+	06.00-28.00-30.50	2	
08137	8103419+	06.30-20.00-25.00	3	
08138	8000447+	06.35-12.50-21.00	4	
08139	8100508*	07.00-18.00-14.00	5	
08140	8100508*	07.00-18.00-14.00	6	
08140	8101558*	07.00-18.00-14.00	6	
08142	0870293700+	07.00-18.00-22.40	7	
08143	8100821*	08.00-20.00-25.00	8	
08144	8000378+	08.00-20.00-25.00	9	
08145	*	08.00-20.00-25.00	10	
08146	8100494*	08.00-20.00-25.20	9	
08147	8101854+	08.00-32.00-30.00	11	
08148	3158651*	08.70-19.00-13.50	12	
08148	8000818*	08.70-19.00-13.50	12	
08148	8158667*	08.70-19.00-13.50	12	
08151	8100867*	08.73-17.65-16.00	13	
08152	8102628+	08.73-17.85-25.40	14	
08153	8101859*	08.80-17.60-13.00	15	
08154	8101859*	08.80-17.60-13.00	16	
08155	8101224*	09.00-13.00-26.50	17	
08156	8101454*	09.00-16.00-25.50	18	
08157	0870315200*	10.00-25.00-17.00	6	
08158	0870315200*	10.00-25.00-17.00	19	
08159	3173283+	10.00-25.00-25.00	20	
08159	8100321+	10.00-25.00-25.00	20	
08161	8100321*	10.00-25.00-25.00	20	

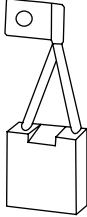

10

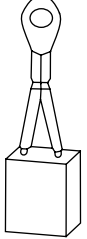

11

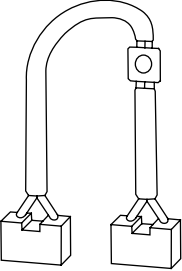

12



13

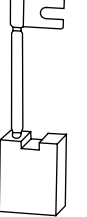

14

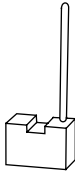

15

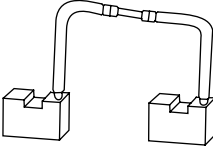

16

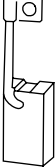

17

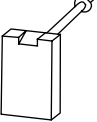



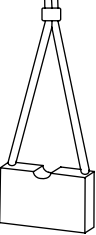

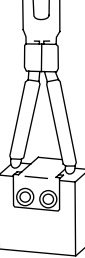

18

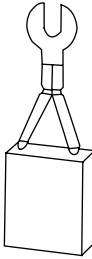
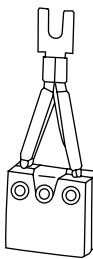
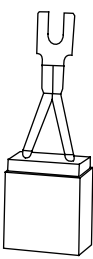
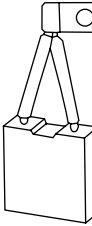

19

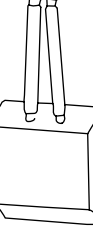
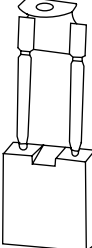
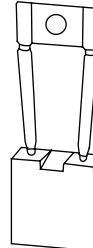
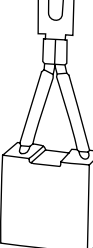
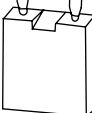
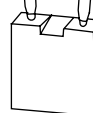
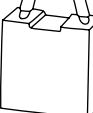
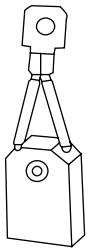

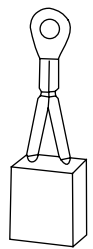
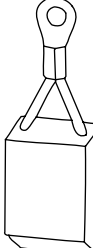
20

CODICE PEDOL	CODICE ORIGINALE	DIMENSIONI T x A x R	POS.	DISEGNI DI RIFERIMENTO		
08162	8000483+	10.00-25.00-25.00	1			
08163	8000029*	10.00-25.00-25.50	2			
08164	8000485+	10.00-25.00-25.50	3			
08150	8000029+	10.00-25.00-25.50	2			
08165	8100685*	10.00-26.00-30.50	4			
08160	8100685+	10.00-26.00-30.50	4			
08166	3072461+	10.00-32.00-25.00	5			
08166	3507677+	10.00-32.00-25.00	5			
08168	3068784+	10.00-32.00-32.00	1	1	2	3
08168	8000452+	10.00-32.00-32.00	1			
08170	8101715+	10.30-25.40-35.00	6			
08171	7700094*	11.11-25.40-30.00	7			
08172	9875610*	11.11-25.40-30.00	8			
08167	7700094+	11.11-25.40-30.00	7			
08173	3117453+	11.11-28.57-30.00	9			
15051	3135064+	12.00-20.00-32.00	10			
15051	8100620+	12.00-20.00-32.00	10			
08174	3135064*	12.00-20.00-32.00	11	4	5	6
08174	8100294*	12.00-20.00-32.00	11			
08176	3000056+	12.00-30.00-30.00	5			
08176	8000054+	12.00-30.00-30.00	5			
08178	8000377+	12.00-32.00-32.00	12			
08179	8000156+	12.50-20.00-40.00	13			
08180	3151391*	12.50-25.00-24.00	14			
08181	3042873+	12.50-25.00-40.00	13			
08181	8000164+	12.50-25.00-40.00	13			
				7	8	9
						
				10	11	12
						
				13	14	

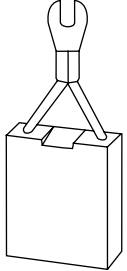
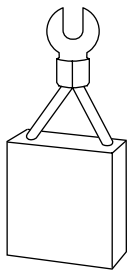
CODICE PEDOL	CODICE ORIGINALE	DIMENSIONI T x A x R	POS.	DISEGNI DI RIFERIMENTO
08183	8000340+	12.50-32.00-40.00	1	
08184	3058554+	12.50-32.00-40.00	2	
08184	3070152+	12.50-32.00-40.00	2	
08184	8000456+	12.50-32.00-40.00	2	
08187	3057701+	12.50-40.00-32.00	3	
08187	8000342+	12.50-40.00-32.00	3	
08189	3131846*	12.70-38.10-51.00	4	
08189	8000027*	12.70-38.10-51.00	4	
08191	3123315+	14.30-31.70-50.80	5	
08191	8000212+	14.30-31.70-50.80	5	
08193	3123315+	14.30-31.70-50.80	6	

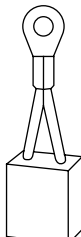

3

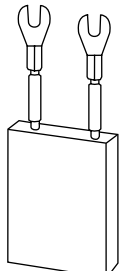

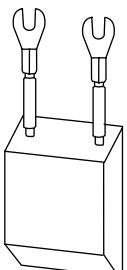

4

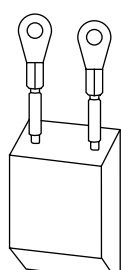

5

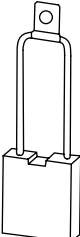
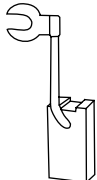
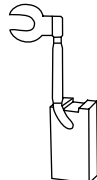

6

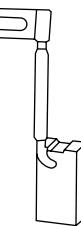
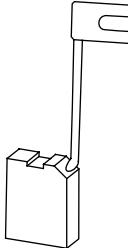
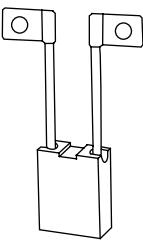
CODICE PEDOL	CODICE ORIGINALE	DIMENSIONI T x A x R	POS.	DISEGNI DI RIFERIMENTO
08199	EG23BOS4*	06.00-22.00-26.00	1	
08200	ES10BOS1*	09.00-13.00-25.50	2	
08200	ES10BOS2*	09.00-13.00-25.50	2	
08200	ES10BOS3*	09.00-13.00-25.50	2	
08200	ES10BOS4*	09.00-13.00-25.50	2	
08200	ES10BOS41*	09.00-13.00-25.50	3	
08205	ES10BOS6+	09.00-13.00-25.50	4	
08206	S10BOS4A*	09.00-13.00-25.50	5	
08169	ES10BOS1-4+	09.00-13.00-25.50	2	
08207	ES24BOS3*	09.00-20.00-28.50	6	
08208	ES24BOS4*	09.00-20.00-28.50	7	
				
				

CODICE PEDOL	CODICE ORIGINALE	DIMENSIONI T x A x R	POS.	DISEGNI DI RIFERIMENTO
-----------------	---------------------	-------------------------	------	---------------------------

08209

*

15.00-40.00-40.00

1

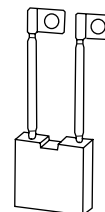

1

CODICE PEDOL	CODICE ORIGINALE	DIMENSIONI T x A x R	POS.	DISEGNI DI RIFERIMENTO		
08210	P18+	00.00-05.50-16.00	1			
08211	P12*	06.30-19.00-16.00	2			
08212	P15+	06.30-22.20-20.60	4	1	2	3
08213	P7+	06.30-22.20-23.80	4			
08214	P5*	06.35-19.05-16.00	3			
08215	P17*	06.40-19.00-16.00	5			
08216	P4*	09.00-20.00-26.00	6			
08217	P16*	09.52-19.00-19.00	7			
08218	P8*	09.52-19.05-19.05	8			
08219	P6*	09.52-19.20-19.20	8			
08220	P2(HY1199362)+	10.30-25.40-35.00	9			
08221	MGG12A(274388)+	10.30-25.40-35.00	10	4	5	6
08222	P9(219982)+	12.50-25.00-37.50	11			
08223	P13(806875)+	12.50-25.00-40.00	12			
08224	+	12.50-25.00-40.00	12			
15050	289058+	12.70-22.22-32.00	13			
08225	P10+	12.70-31.75-32.14	14			
08226	P11+	12.70-31.80-38.00	16			
08227	+	12.70-32.14-35.00	9			
08228	MGP127M+	13.90-25.40-35.00	15	7	8	9
08229	+	13.90-25.40-35.00	17			
08230	*	15.87-38.10-51.00	19			
08175	+	15.87-38.10-51.00	19			
08231	P1+	19.05-31.75-44.05	18			
				10	11	12
				13	14	15
				16	17	18
				19	20	21

CODICE PEDOL	CODICE ORIGINALE	DIMENSIONI T x A x R	POS.	DISEGNI DI RIFERIMENTO
-----------------	---------------------	-------------------------	------	---------------------------

08620	*	06.00-28.00-30.50	1
08621	*	09.00-13.00-25.50	2
08622	*	09.00-13.00-25.50	3

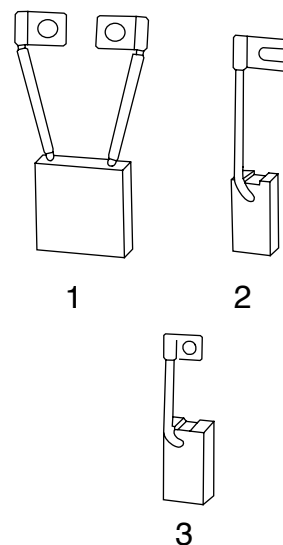

CODICE PEDOL	CODICE ORIGINALE	DIMENSIONI T x A x R	POS.	DISEGNI DI RIFERIMENTO
08232	+	16.00-20.00-32.00	1	

1

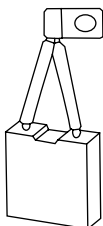
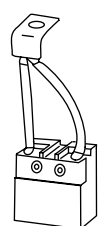
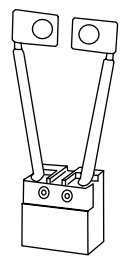
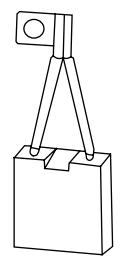
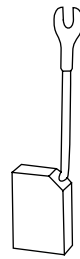
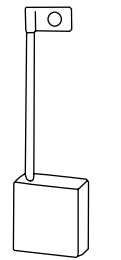
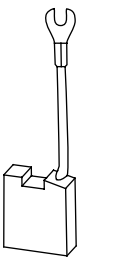
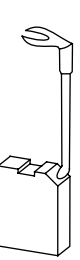
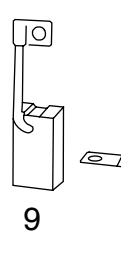
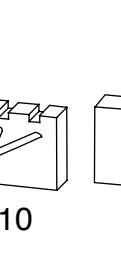
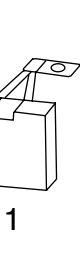
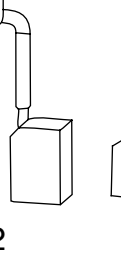
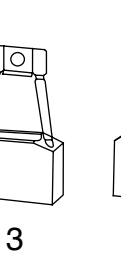
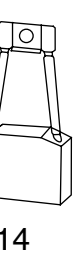
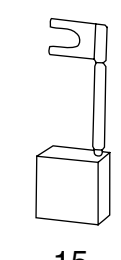
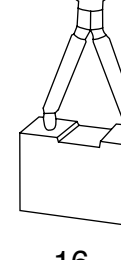
CODICE PEDOL	CODICE ORIGINALE	DIMENSIONI T x A x R	POS.	DISEGNI DI RIFERIMENTO
08233	28710030*	06.00-22.00-25.00	1	
08177	28710030+	06.00-22.00-25.00	1	
08234	28706450*	06.00-22.00-25.50	2	
08182	28706450+	06.00-22.00-25.50	2	
08235	27500310*	06.00-28.00-30.50	3	
08235	27503060*	06.00-28.00-30.50	3	
08235	28704010*	06.00-28.00-30.50	3	
08235	28707090*	06.00-28.00-30.50	3	
08239	27503060+	06.00-28.00-30.50	1	
08240	28710260*	06.00-28.00-30.50	4	
08185	+	06.00-28.00-30.50	3	
08186	28710260+	06.00-28.00-30.50	4	
08241	28701390+	08.00-16.00-25.00	5	
08242	16011618+	08.00-20.00-23.00	6	
08243	28700020*	08.00-20.00-26.00	7	
16529	28711090*	08.00-20.00-26.00	8	
16529	28712260*	08.00-20.00-26.00	8	
08244	28704040*	08.00-28.00-30.50	3	
08245	28704040*	08.00-28.00-30.50	4	
08188	28704040+	08.00-28.00-30.50	3	
08190	28704040+	08.00-28.00-30.50	4	
16541	27501730*	09.00-13.00-25.50	9	
16541	27503310*	09.00-13.00-25.50	9	
54419	28715920	09.00-13.00-25.50	9	
08247	28710770*	09.00-26.00-25.50	10	
08248	*	09.00-26.00-25.50	11	
08249	28712270*	10.00-16.00-25.00	12	
08250	27502820*	10.00-25.00-20.00	13	
08192	27502820+	10.00-25.00-20.00	13	
08251	070282*	10.00-25.00-22.00	14	
08251	28710150*	10.00-25.00-22.00	14	
08201	+	10.00-25.00-22.00	14	
16539	28711160*	10.00-25.00-25.00	15	
16539	28700490*	10.00-25.00-25.00	15	
08253	27502900*	12.00-20.00-35.00	16	

CODICE PEDOL	CODICE ORIGINALE	DIMENSIONI T x A x R	POS.	DISEGNI DI RIFERIMENTO
08254	16011617*	12.50-16.00-25.00	1	
16507	28700110*	12.50-16.00-25.00	2	
16507	28700140*	12.50-16.00-25.00	2	
08255	28711130*	12.50-16.00-25.00	3	
08202	28711130+	12.50-16.00-25.00	3	
08204	+	12.50-16.00-25.00	2	
16506	28705330*	12.50-20.00-25.00	3	
16506	28711240*	12.50-20.00-25.00	3	
08256	28702150*	12.50-20.00-32.00	4	
08257	+	12.50-20.00-32.00	5	
08203	28702150+	12.50-20.00-32.00	4	
16508	28700060*	12.50-25.00-30.00	1	
08258	28714350*	12.50-32.00-33.00	6	
08259	28700080*	16.00-16.00-25.00	7	
08259	28701980*	16.00-16.00-25.00	7	
08261	28701730+	16.00-20.00-32.00	4	
08262	28701710*	16.00-20.00-32.00	4	
08263	+	16.00-20.00-32.00	5	
16505	28700510+	20.00-20.00-32.00	8	
16505	28711170+	20.00-20.00-32.00	8	
08264	28701850+	20.00-20.00-32.00	9	
08265	28712250*	20.00-20.00-32.00	10	
08266	28705460*	20.00-25.00-25.00	11	

CODICE PEDOL	CODICE ORIGINALE	DIMENSIONI T x A x R	POS.	DISEGNI DI RIFERIMENTO
--------------	------------------	----------------------	------	------------------------

08267	9224170013*	08.00-20.00-25.00	1	
08236	9224170013+	08.00-20.00-25.00	1	
08268	9224160002+	12.50-32.00-30.50	2	
08269	9224170014+	15.87-38.10-50.80	3	
08270	E7237558+	16.00-40.00-50.00	4	

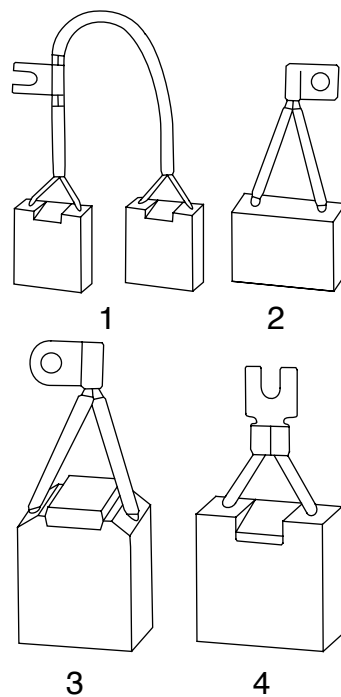

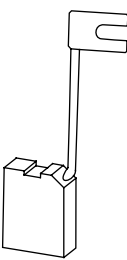
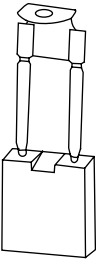
CODICE PEDOL	CODICE ORIGINALE	DIMENSIONI T x A x R	POS.	DISEGNI DI RIFERIMENTO
08271	6700053*	09.00-20.00-28.50	1	
08271	670024*	09.00-20.00-28.50	1	
08273	7700094*	11.11-25.40-30.00	2	
08272	7700094+	11.11-25.40-30.00	2	
				

1

2

CODICE PEDOL	CODICE ORIGINALE	DIMENSIONI T x A x R	POS.	DISEGNI DI RIFERIMENTO
-----------------	---------------------	-------------------------	------	---------------------------

08274	+	06.00-13.00-21.00	1	
08275	*	09.00-18.00-25.00	2	
08276	406574*	10.00-16.00-28.00	3	
08237	406574+	10.00-16.00-28.00	3	
08277	FB91-40566+	10.00-20.00-20.00	4	
08278	FB1-51740-0330*	10.00-20.00-20.00	5	
08279	FB1-51740-0400+	10.00-27.00-30.00	6	
08280	4061183*	10.00-28.00-30.50	7	
08238	4061183+	10.00-28.00-30.50	7	
08281	*	10.00-31.00-25.00	8	
08282	KF1-51740-0440+	10.00-32.00-40.00	9	
08283	FB1-51740-0260+	11.00-30.00-33.00	10	
08284	FB1-51740-0390+	11.00-60.00-33.00	11	
08285	FB91-40566*	14.00-40.00-27.00	12	
08252	FB91-40566+	14.00-40.00-27.00	12	
08286	FBD-51740-0650+	14.00-40.00-33.00	9	
08287	FB91-40590*	16.00-40.00-34.00	13	
08246	FB91-40590+	16.00-40.00-34.00	13	

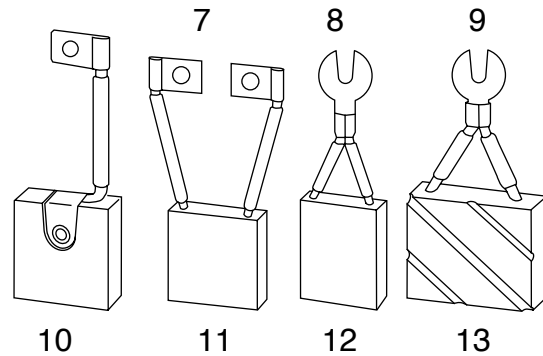
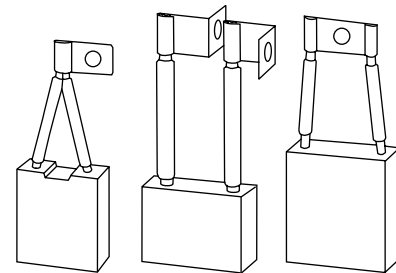
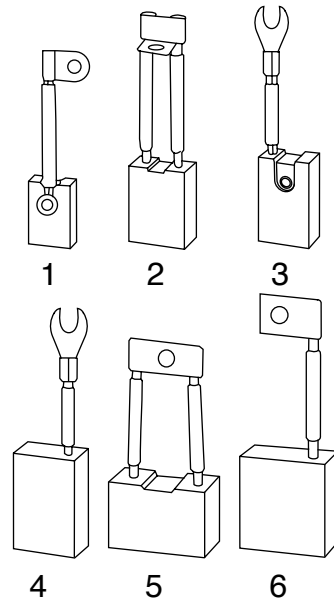

CODICE PEDOL	CODICE ORIGINALE	DIMENSIONI T x A x R	POS.	DISEGNI DI RIFERIMENTO
08288	1041012/0004*	06.00-22.00-25.50	1	
08289	1007607/0004*	06.30-27.00-19.00	2	
08260	1007607/0004+	06.30-27.00-19.00	2	
08290	1007657/0004*	06.40-16.00-14.00	3	
08291	1002725/0001*	06.40-16.00-19.00	4	
08305	1002725/0001+	06.40-16.00-19.00	4	
08292	*	08.00-12.50-22.00	5	
15044	+	08.00-12.50-22.00	5	
08293	5762672/0001*	08.00-22.00-28.50	6	
15045	5762672/0001+	08.00-22.00-28.50	6	
08294	EFP5*	08.00-28.00-30.50	7	
15046	EFP5+	08.00-28.00-30.50	7	
08295	1041647/0004*	08.80-17.70-15.40	8	
15047	1041647/0004+	08.80-17.70-15.40	8	
08296	1055200/0001+	08.86-17.78-25.40	10	
08297	D11208/0004*	09.52-22.22-25.40	9	
08298	1034971/0004*	09.52-22.22-27.00	9	
08299	1120800*	09.52-22.22-30.00	11	
15048	1120800+	09.52-22.22-30.00	11	
08300	1006454+	09.52-25.40-27.00	12	
08301	1009475*	09.52-31.75-25.40	13	
15049	1009475+	09.52-31.75-25.40	13	
08302	1007935/0004+	09.52-31.75-27.00	14	
08303	1009599/0004*	09.52-31.75-27.00	18	
15052	1009599/0004+	09.52-31.75-27.00	18	
08304	1009285/0004+	09.52-38.10-22.20	18	
08304	1024269/0004+	09.52-38.10-22.20	18	
08306	1009106/0004*	09.52-38.10-22.20	15	
08307	1045330/0004+	09.52-38.10-22.20	16	
08308	1060941+	09.52-38.10-22.20	17	
08309	1009285/0004+	09.52-38.10-22.50	14	
08310	1009092/0001*	09.52-38.10-26.70	19	
15053	1009092/0001+	09.52-38.10-26.70	19	
08311	1007934/0004+	09.52-38.10-27.00	18	
08312	1024337+	09.52-38.10-27.00	18	
08313	1009092/0004*	09.52-38.10-27.00	19	
15054	1009092/0004+	09.52-38.10-27.00	19	

CODICE PEDOL	CODICE ORIGINALE	DIMENSIONI T x A x R	POS.	DISEGNI DI RIFERIMENTO
--------------	------------------	----------------------	------	------------------------

08314	1007722/0004*	10.00-23.00-30.00	1
08323	1007722/0004+	10.00-23.00-30.00	1
08315	5762670/0001+	10.00-25.00-22.00	2
08316	1045174+	10.00-25.00-31.00	3
08317	1044854/0001*	10.00-32.00-31.00	4
08318	1049974/0001+	10.00-40.00-30.00	5
08319	1041478/0004+	10.00-40.00-30.00	5
08320	1060834/0001+	10.00-40.00-46.00	6
08321	1054692/0001+	10.30-25.40-44.50	7
08322	1009106/0004+	11.11-25.40-25.40	4
08322	1009254/0004+	11.11-25.40-25.40	4
08322	1024089/0008+	11.11-25.40-25.40	4
08322	1025138/0008+	11.11-25.40-25.40	4
08326	1031460/0004+	11.11-25.40-25.40	8
08327	1008778/0001+	11.11-25.40-25.40	8
08328	1009254/0004+	11.11-25.40-25.40	9
08329	+	12.50-40.00-46.00	6
08330	1008735/0008+	12.70-22.22-32.00	1
08331	1008733/0004*	15.87-38.10-50.00	10
08332	1008731/0004+	15.87-38.10-50.80	11
08333	1025719+	16.00-38.00-60.00	13
08334	1049669/0004+	16.00-40.00-40.00	14
08335	1060826/0001*	16.00-40.00-46.00	6
08324	1060826/0001+	16.00-40.00-46.00	6
08336	1037167/0001+	16.00-40.00-53.00	15
08651	+	17.00-35.00-30.00	18
08337	1006827/0008*	19.05-28.57-50.80	16
08325	1006827/0008+	19.05-28.57-50.80	16
08338	+	20.00-08.00-25.00	11
08339	1036540/0001+	20.00-40.00-33.00	17

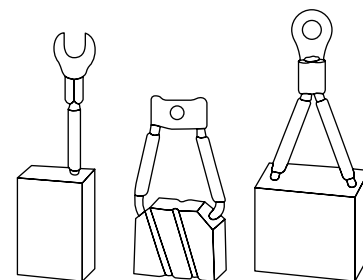

1 2 3

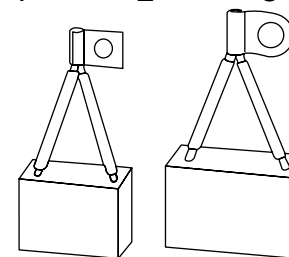

4 5

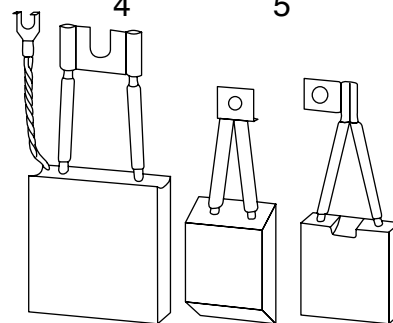

6 7 8

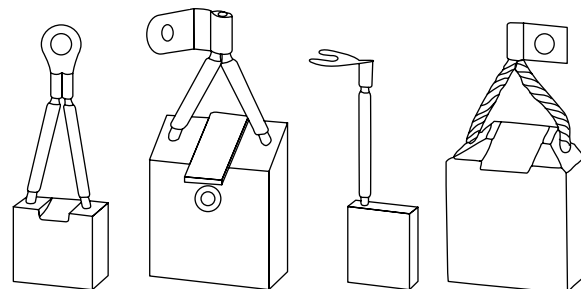

9 10 11

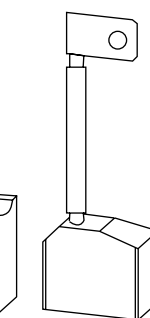

12

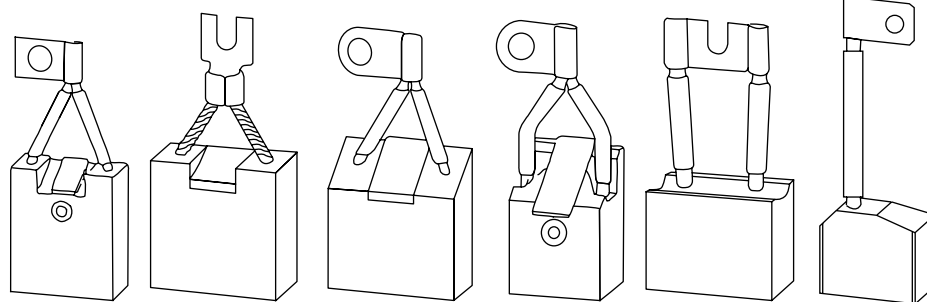



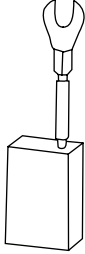
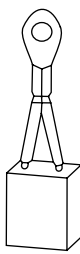
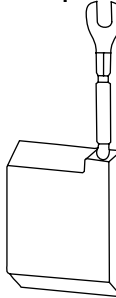
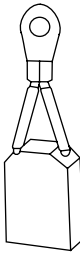

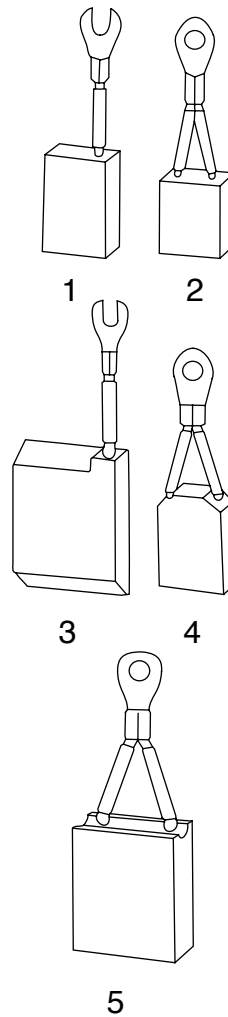
13 14 15 16 17 18

CODICE PEDOL	CODICE ORIGINALE	DIMENSIONI T x A x R	POS.	DISEGNI DI RIFERIMENTO
08340	CB200V18+	08.00-20.00-30.00	1	 
08341	+	08.00-32.00-30.00	2	
08342	+	08.00-32.00-32.00	1	
08343	+	09.50-31.70-47.60	3	
08344	+	12.00-20.00-32.00	1	
08345	*	12.00-20.00-32.00	4	 
08346	P/N2100098+	12.00-32.00-32.00	2	
08346	P/N2101348+	12.00-32.00-32.00	2	
08348	P/N2101327+	16.00-32.00-50.00	5	
08349	P/N2101328+	16.00-40.00-50.00	5	

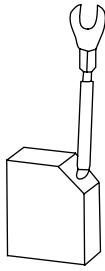
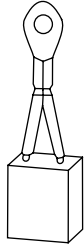

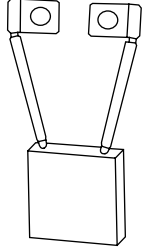

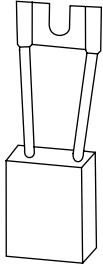
CODICE PEDOL	CODICE ORIGINALE	DIMENSIONI T x A x R	POS.	DISEGNI DI RIFERIMENTO
08350	0009718118+	06.00-12.50-22.00	1	
15119	0009718120*	08.00-12.50-22.00	2	
08351	0009718115*	08.00-12.50-22.00	2	
15067	0009718120+	08.00-12.50-22.00	2	
15106	0009718103*	08.00-32.00-31.00	3	
15057	0009718103+	08.00-32.00-31.00	3	
08352	2243209900+	08.00-32.00-32.00	4	
08353	0009718106*	10.00-12.50-22.00	5	
08347	0009718106+	10.00-12.50-22.00	5	
15117	0009718113*	10.00-12.50-22.50	2	
15066	0009718113+	10.00-12.50-22.50	2	
15114	0009718108+	10.00-16.00-31.00	6	
15115	0009718109*	10.00-25.00-20.00	7	
15064	0009718109+	10.00-25.00-20.00	7	
15112	0009718104*	10.00-26.00-30.00	8	
15062	0009718104+	10.00-26.00-30.00	8	
08354	*	10.00-26.00-31.00	9	
15113	0009718105*	10.00-32.00-31.00	10	
15063	0009718105+	10.00-32.00-31.00	10	
08355	*	12.00-31.00-31.00	11	
15055	+	12.00-31.00-31.00	11	
15105	0009718111*	12.50-25.00-32.00	12	
15105	0009718119*	12.50-25.00-32.00	12	
15056	000971811+	12.50-25.00-32.00	12	
15108	0009718114*	12.50-32.00-32.00	11	
15109	0009718117*	12.50-32.00-32.00	11	
15111	0009718124*	12.50-32.00-32.00	11	
15058	0009718114+	12.50-32.00-32.00	11	
15059	0009718117+	12.50-32.00-32.00	11	
15061	0009718124+	12.50-32.00-32.00	11	
15116	0009718110*	12.50-32.00-40.00	13	
08356	0009718107+	12.50-32.00-40.00	13	
15110	0009718116*	12.50-32.00-40.00	14	
15060	0009718116+	12.50-32.00-40.00	14	
15065	0009718110+	12.50-32.00-40.00	13	

CODICE PEDOL	CODICE ORIGINALE	DIMENSIONI T x A x R	POS.	DISEGNI DI RIFERIMENTO	
08608	2803212+	06.00-28.00-30.00	4		
08609	2803123+	08.00-16.00-25.00	5		
08607	2807218+	10.00-20.00-32.00	3		
08606	2803271+	12.00-32.00-32.00	2		
08605	2807212+	12.50-20.00-32.00	1		
08610	TIPO/PME+	16.00-25.00-32.00	6		
					

CODICE PEDOL	CODICE ORIGINALE	DIMENSIONI T x A x R	POS.	DISEGNI DI RIFERIMENTO
--------------	------------------	----------------------	------	------------------------

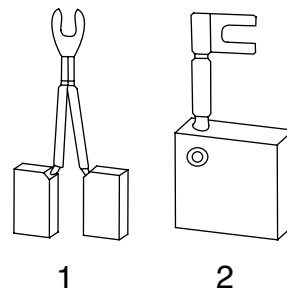
08357	+	06.30-12.50-22.00	1	
08358	EX131+	12.50-32.00-32.00	2	

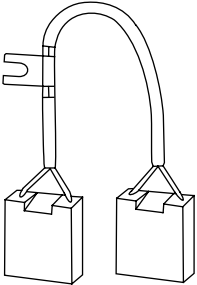
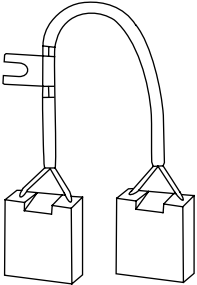
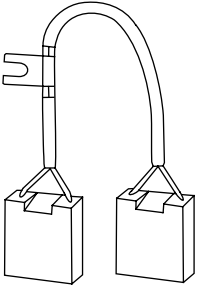
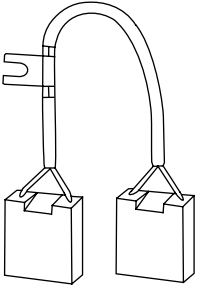
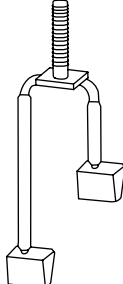

CODICE PEDOL	CODICE ORIGINALE	DIMENSIONI T x A x R	POS.	DISEGNI DI RIFERIMENTO
08359	71.30100*	08.00-20.00-25.00	1	
08360	200086050*	08.00-20.00-25.00	2	
08360	71.30980*	08.00-20.00-25.00	2	
08360	71.31161*	08.00-20.00-25.00	2	
08361	+	08.00-20.00-25.00	2	
08363	71.30870*	08.23-10.62-12.70	3	

CODICE PEDOL	CODICE ORIGINALE	DIMENSIONI T x A x R	POS.	DISEGNI DI RIFERIMENTO
-----------------	---------------------	-------------------------	------	---------------------------

08364

*

06.40-19.00-19.50

1

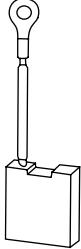
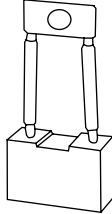
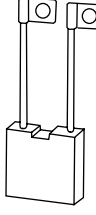

1

CODICE PEDOL	CODICE ORIGINALE	DIMENSIONI T x A x R	POS.	DISEGNI DI RIFERIMENTO
08365	29242-L4500*	06.40-21.00-25.00	1	
08366	29042-L5000*	14.50-30.00-21.50	2	
08362	29242-L5000+	14.50-30.00-21.50	2	
08367	29042-L4000*	15.00-40.00-26.00	3	
15068	29042-L4000+	15.00-40.00-26.00	3	

CODICE PEDOL	CODICE ORIGINALE	DIMENSIONI T x A x R	POS.	DISEGNI DI RIFERIMENTO
--------------	------------------	----------------------	------	------------------------

08368	617270310+	08.00-16.00-25.00	1	
08369	192431009+	08.00-20.00-22.50	2	
08370	193431021*	08.00-22.50-23.00	3	
15069	193431021+	08.00-22.50-23.00	3	
08371	617270251+	12.50-25.00-33.00	4	
08372	617270241*	12.50-40.00-25.50	5	
08373	617270131*	12.50-40.00-25.50	6	
15070	617270241+	12.50-40.00-25.50	5	
15071	617270131+	12.50-40.00-25.50	6	

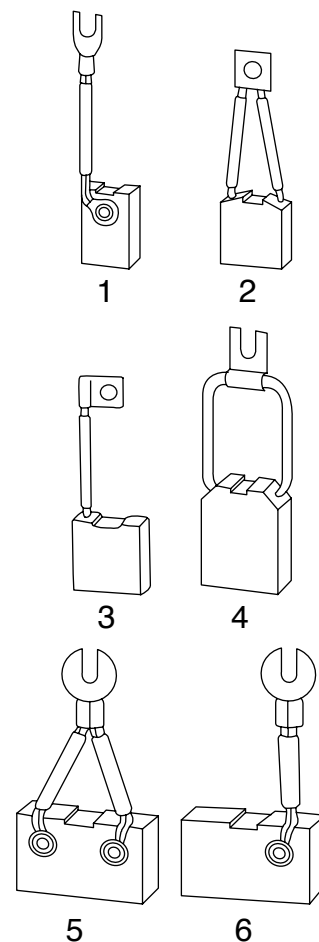

CODICE PEDOL	CODICE ORIGINALE	DIMENSIONI T x A x R	POS.	DISEGNI DI RIFERIMENTO
08374	E30/E35+	12.50-25.00-32.00	1	

1

CODICE PEDOL	CODICE ORIGINALE	DIMENSIONI T x A x R	POS.	DISEGNI DI RIFERIMENTO
08375	9815205*	06.00-28.00-30.00	1	
15135	9815205+	06.00-28.00-30.00	1	
08194	+	06.00-28.00-30.50	1	
08630	9817893*	06.00-28.00-30.50	10	
08634	9835641+	06.00-28.00-30.50	9	
08635	+	06.00-28.00-30.50	9	
08636	9815734+	08.00-10.00-22.00	4	
08629	9817878*	08.00-28.00-30.50	10	
15134	9819263*	08.00-28.00-30.50	10	
08631	9818769*	08.00-28.00-33.50	6	
08195	9816458+	10.00-20.00-20.00	3	
08376	+	10.00-20.00-20.00	3	
08377	9835830+	12.50-20.00-30.00	2	
08377	9837338+	12.50-20.00-30.00	2	
08196	9270807+	12.50-25.00-32.00	7	
08197	+	12.50-32.00-25.00	5	
08633	9815254*	12.50-32.00-25.00	5	
08628	+	12.50-32.00-32.00	11	
08632	+	12.50-32.00-32.00	12	
08198	9835686*	16.00-25.00-45.00	8	
15137	9819182+ Kit	12.50-32.00-32.00	11	
15138	9818722+ Kit	12.50-32.00-32.00	12	

CODICE PEDOL	CODICE ORIGINALE	DIMENSIONI T x A x R	POS.	DISEGNI DI RIFERIMENTO
08641	9910419130			
08642	9910419168			
08643	9940946229			
08644	9940946205			
08645	9940946206			
08637	9940946227*	08. 00-28.00-30.50	1	
08638	9940946400*	09.00-16.00-20.00	2	
08640	9940946410*	10.00-20.00-20.00	3	
08639	9940946360*	10.00-20.00-25.00	3	

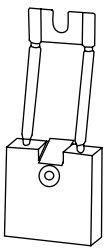
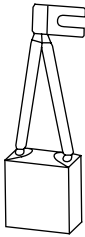
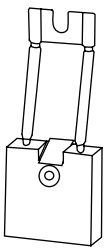
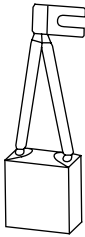
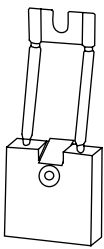
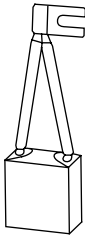
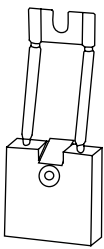
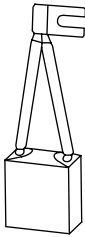
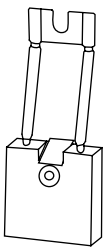
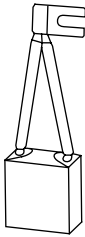
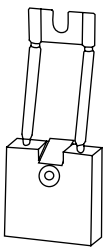
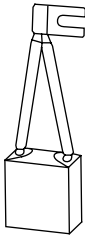
CODICE PEDOL	CODICE ORIGINALE	DIMENSIONI T x A x R	POS.	DISEGNI DI RIFERIMENTO	
08378	973*	06.00-28.00-30.00	1		
08378	974*	06.00-28.00-30.00	1		
08379	973-4+	06.00-28.00-30.00	1		
08380	10419+	07.30-20.00-25.00	2		
08381	112338+	08.00-20.00-32.00	3		
08382	102798*	08.00-32.00-30.00	4		
15072	102798+	08.00-32.00-30.00	4		
08383	111746*	10.00-25.00-20.00	5		
08384	111746+	10.00-25.00-20.00	5		
15073	111746+	10.00-25.00-20.00	5		
08385	27571*	12.50-25.00-24.00	6		

CODICE PEDOL	CODICE ORIGINALE	DIMENSIONI T x A x R	POS.	DISEGNI DI RIFERIMENTO
15102	023732*	06.00-28.00-30.50	1	
15104	029141*	08.00-28.00-30.00	1	
08582	023731+	09.00-13.00-25.00	2	
08584	022429*	09.00-26.00-25.50	4	
08585	023086+	10.00-26.00-30.00	5	
08583	023086+	12.00-20.00-30.00	3	

CODICE PEDOL	CODICE ORIGINALE	DIMENSIONI T x A x R	POS.	DISEGNI DI RIFERIMENTO
-----------------	---------------------	-------------------------	------	---------------------------

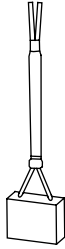
08386	1007657/4*	06.35-15.87-13.50	1	
08387	1034971*	09.52-22.22-30.00	2	
15074	1034971+	09.52-22.22-30.00	2	

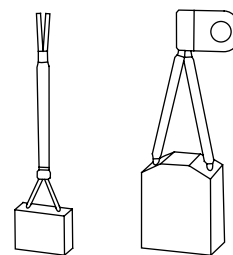

1

2

CODICE PEDOL	CODICE ORIGINALE	DIMENSIONI T x A x R	POS.	DISEGNI DI RIFERIMENTO
08388	507091*	08.00-28.00-30.50	1	
15075	507091+	08.00-28.00-30.50	1	
08389	505677*	09.00-20.00-28.50	2	

CODICE PEDOL	CODICE ORIGINALE	DIMENSIONI T x A x R	POS.	DISEGNI DI RIFERIMENTO
-----------------	---------------------	-------------------------	------	---------------------------

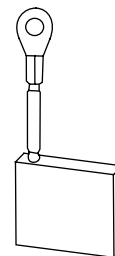

08390	800221+	08.00-20.00-32.00	1	
-------	---------	-------------------	---	--

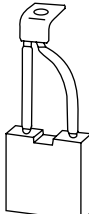
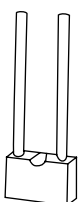
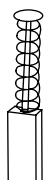
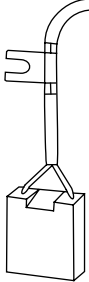
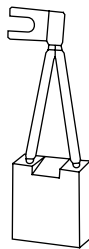
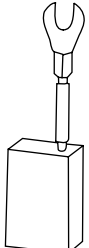
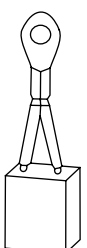
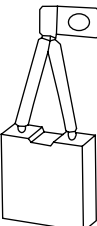
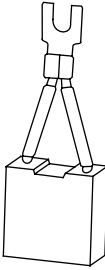
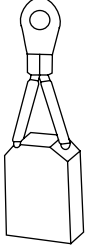
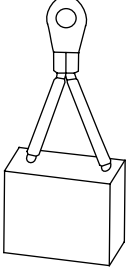
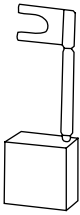
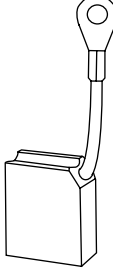

1

CODICE PEDOL	CODICE ORIGINALE	DIMENSIONI T x A x R	POS.	DISEGNI DI RIFERIMENTO
08615	*	06.00-28.00-30.50	1	
08616	*	08.00-28.00-30.50	2	
08617	*	09.00-13.00-25.50	3	
08618	*	09.00-13.00-25.50	4	
08619	*	10.00-12.50-22.50	5	

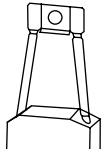
CODICE PEDOL	CODICE ORIGINALE	DIMENSIONI T x A x R	POS.	DISEGNI DI RIFERIMENTO
08391	25431580*	06.00-22.00-25.50	1	  
08392	26003070*	07.00-18.00-14.00	2	
08393	902016010+	08.00-09.00-24.00	3	
08394	910057810*	08.00-20.00-25.00	4	 
08398	910057810+	08.00-20.00-25.00	4	
08395	903082900*	08.00-20.00-25.20	5	  
08396	902016260+	08.00-20.00-32.00	6	
08397	750059+	08.00-32.00-30.00	7	  
08397	902016130+	08.00-32.00-30.00	7	
08399	23622830*	10.00-26.00-30.00	8	 
08404	23622830+	10.00-26.00-30.00	8	
08400	902016200+	11.11-28.57-30.00	9	
08401	902016140+	12.00-20.00-32.00	10	
08402	750080+	12.00-32.00-32.00	11	
08403	902016120+	12.00-32.00-32.00	7	
08403	902016230+	12.00-32.00-32.00	7	
08405	902016060+	12.50-20.00-30.00	12	
08406	073970179*	25.00-12.00-30.00	13	

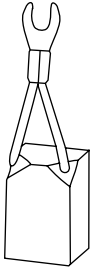
CODICE PEDOL	CODICE ORIGINALE	DIMENSIONI T x A x R	POS.	DISEGNI DI RIFERIMENTO
08407	24825-22*	10.00-25.00-22.00	1	  
15076	24825-22+	10.00-25.00-22.00	1	
08408	+	12.50-20.00-32.00	2	
08409	+	16.00-20.00-32.00	2	
08410	+	16.00-20.00-40.00	3	
08411	*	16.00-25.00-32.00	2	
15077	+	16.00-25.00-32.00	2	

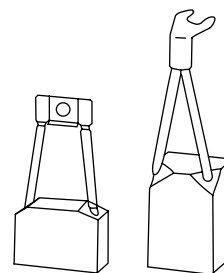

1 2

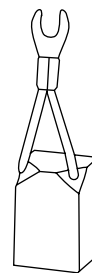

3

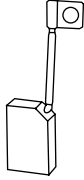
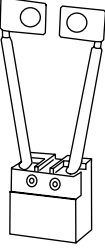
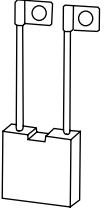
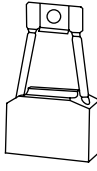
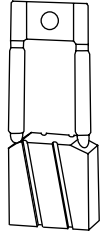
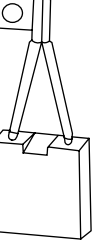
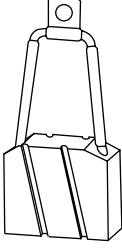
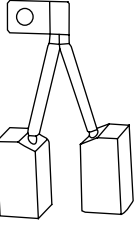
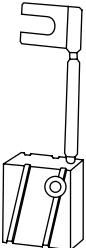
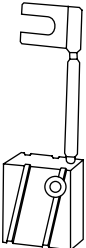
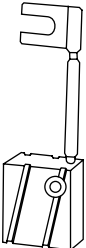
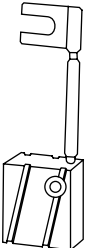
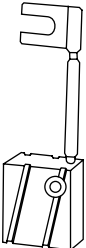
CODICE PEDOL	CODICE ORIGINALE	DIMENSIONI T x A x R	POS.	DISEGNI DI RIFERIMENTO
08412	023067+	06.00-16.00-22.10	1	  
08413	003470*	06.00-28.00-30.50	2	
08414	005045*	06.00-28.00-30.50	6	
15078	003470+	06.00-28.00-30.50	2	  
15079	005045+	06.00-28.00-30.50	6	
08415	013342*	08.00-28.00-30.50	2	
08416	015030*	08.00-28.00-30.50	3	 
15080	013342+	08.00-28.00-30.50	2	
15081	015030+	08.00-28.00-30.50	3	
08417	022393*	10.00-12.50-25.00	1	
15082	022393+	10.00-12.50-25.00	1	
08418	005223*	10.00-25.00-22.00	4	
15083	005223+	10.00-25.00-22.00	4	
08419	C843*	10.00-25.00-28.50	5	
08420	019082/D25+	10.00-26.00-31.00	6	
08421	019785*	10.00-32.00-31.00	7	
08422	2019502+	10.00-32.00-31.00	7	
08423	016264*	10.00-32.00-31.00	3	
15084	019785+	10.00-32.00-31.00	7	
15085	016264+	10.00-32.00-31.00	3	
08424	005252*	12.50-12.50-25.00	8	
08425	019082*	16.00-20.00-25.00	9	

CODICE PEDOL	CODICE ORIGINALE	DIMENSIONI T x A x R	POS.	DISEGNI DI RIFERIMENTO	
08426	0142873+	06.00-12.50-22.00	1		
08427	0870645*	06.00-22.00-25.50	2		
08428	0135724*	06.00-22.00-25.50	3		
08432	0870645+	06.00-22.00-25.50	2		
08433	0135724+	06.00-22.00-25.50	3		
08429	0018088*	06.00-28.00-30.50	4		
08435	0018088+	06.00-28.00-30.50	4		
08431	0071241*	08.00-10.00-20.00	5		
08431	0085818*	08.00-10.00-20.00	5		
08431	0273445*	08.00-10.00-20.00	5		
08434	0071237*	08.00-10.00-20.00	6		
08434	0085783*	08.00-10.00-20.00	6		
08436	+	08.00-10.00-20.00	7		
08439	+	08.00-10.00-20.00	5		
08437	*	08.00-10.00-25.00	7		
08442	+	08.00-10.00-25.00	7		
08438	0071238*	08.00-12.50-25.00	6		
08438	0085784*	08.00-12.50-25.00	6		
08440	*	08.00-12.50-25.00	6		
08444	+	08.00-12.50-25.00	6		
08441	0090831*	08.00-16.00-25.00	8		
08441	0090843*	08.00-16.00-25.00	8		
08443	0071240+	08.00-25.00-32.00	9		
08443	0085795+	08.00-25.00-32.00	9		
08443	0085796+	08.00-25.00-32.00	9		
08446	+	08.00-28.00-30.50	4		
08447	*	09.53-20.00-31.75	10		
08448	0071242*	10.00-12.50-25.00	6		
08448	0085817*	10.00-12.50-25.00	6		
08445	+	10.00-12.50-25.00	6		
15122	0071249*	10.00-16.00-25.00	8		
15122	0085787*	10.00-16.00-25.00	8		
15122	0085788*	10.00-16.00-25.00	8		
08449	0344640+	10.00-16.00-25.00	8		

CODICE PEDOL	CODICE ORIGINALE	DIMENSIONI T x A x R	POS.	DISEGNI DI RIFERIMENTO
15122	0273414*	10.00-16.00-25.00	1	
15122	0273446*	10.00-16.00-25.00	1	
08450	0323734*	10.00-16.00-25.00	2	
15099	+	10.00-16.00-25.00	1	
08451	0085790*	10.00-20.00-25.00	1	
08451	0085800*	10.00-20.00-25.00	1	
08453	*	10.00-20.00-25.00	3	
08452	0085800+	10.00-20.00-25.00	1	
08456	+	10.00-20.00-25.00	3	
08454	*	10.00-25.00-31.00	3	
08457	+	10.00-25.00-31.00	3	
08455	0085798*	10.00-25.00-32.00	4	
08455	0085799*	10.00-25.00-32.00	4	
08455	0085804*	10.00-25.00-32.00	4	
08458	0085797*	10.00-25.00-32.00	3	
08460	+	10.00-25.00-32.00	4	
15094	0085797+	10.00-25.00-32.00	3	
08459	0071150*	12.50-16.00-25.00	1	
08459	0085789*	12.50-16.00-25.00	1	
08461	*	12.50-16.00-25.00	3	
15095	+	12.50-16.00-25.00	1	
15096	+	12.50-16.00-25.00	3	
08462	+	12.50-16.00-32.00	3	
15123	0085809*	12.50-25.00-31.00	1	
15123	0085803*	12.50-25.00-32.00	1	
15123	0085806*	12.50-25.00-32.00	1	
15123	0085807*	12.50-25.00-32.00	1	
15123	0085810*	12.50-25.00-32.00	1	
15123	0085819*	12.50-25.00-32.00	1	
15120	0277719*	12.50-25.00-32.00	1	
15128	0071152+	12.50-25.00-32.00	5	
15128	0085805+	12.50-25.00-32.00	5	
15128	0320790+	12.50-25.00-32.00	5	
08463	*	12.50-25.00-32.00	3	
15097	+	12.50-25.00-32.00	3	
15098	0277719+	12.50-25.00-32.00	1	
15132	+	12.50-25.00-32.00	1	

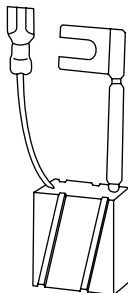
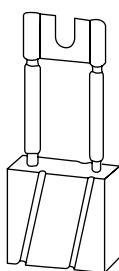
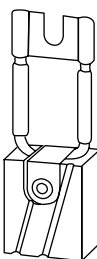
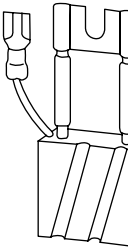
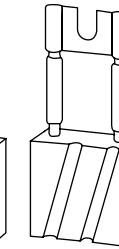
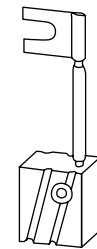
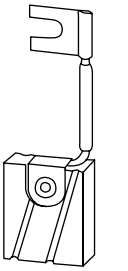
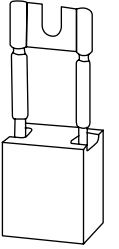
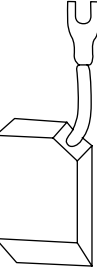
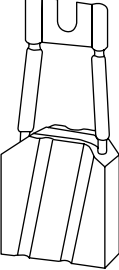
CODICE PEDOL	CODICE ORIGINALE	DIMENSIONI T x A x R	POS.	DISEGNI DI RIFERIMENTO	
08464	0323735+	12.50-25.00-32.00	1		
08464	0325800+	12.50-25.00-32.00	1		
15121	0085812*	12.50-32.00-32.00	2		
15121	0085813*	12.50-32.00-32.00	2		
15121	0085814*	12.50-32.00-32.00	2		
15121	0085815*	12.50-32.00-32.00	2		
15121	0085816*	12.50-32.00-32.00	2		
08466	0325802*	12.50-32.00-32.00	2		
08467	0136107*	12.50-32.00-32.00	3		
08468	0325801+	12.50-32.00-32.00	4		
08468	5142647+	12.50-32.00-32.00	4		
08470	0323732*	12.50-32.00-32.00	4		
08465	0325802+	12.50-32.00-32.00	2		
08469	0136107+	12.50-32.00-32.00	3		
08476	+	12.50-32.00-32.00	2		
08471	0301347+	12.50-32.00-40.00	2		
15125	0273442+	12.50-32.00-40.00	5		
15126	0282422*	12.50-32.00-40.00	10		
08472	0085792*	16.00-20.00-25.00	6		
08472	0085793*	16.00-20.00-25.00	6		
08474	*	16.00-20.00-25.00	7		
08475	0071160*	16.00-25.00-32.00	2		
08475	0085811*	16.00-25.00-32.00	2		
08477	+	16.00-25.00-32.00	3		
08473	+	16.00-25.00-32.00	2		
08478	+	16.00-25.00-40.00	8		
08479	+	16.00-25.00-42.00	9		
15124	0257185*	16.00-32.00-32.00	2		
15124	0265634*	16.00-32.00-32.00	2		
15133	+	16.00-32.00-32.00	2		
					
					
					
					
					
					

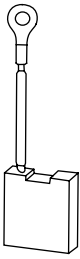
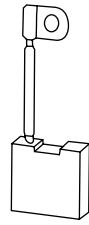
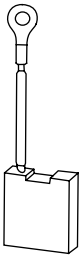
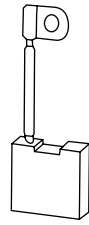
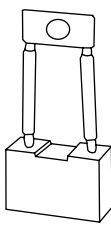
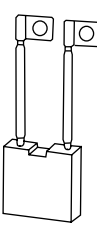
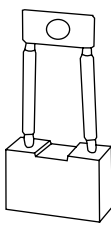
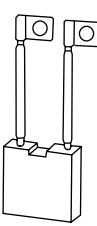
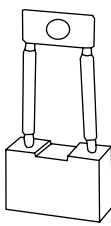
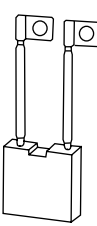
CODICE PEDOL	CODICE ORIGINALE	DIMENSIONI T x A x R	POS.	DISEGNI DI RIFERIMENTO
08480	60200201*	06.40.-21.00-25.00	1	
08480	60200219*	06.40-21.00-25.00	1	
08480	MP405-1301*	06.40-21.00-25.00	1	
08480	MT405-1304*	06.40-21.00-25.00	1	
08484	MP405-3301+	07.50-15.00-24.00	2	
08485	60200235*	08.00-28.00-26.00	3	
08485	MP725-1301*	08.00-28.00-26.00	3	
08485	MT425-1301*	08.00-28.00-26.00	3	
08481	+	08.00-28.00-26.00	3	
08488	60200789*	14.00-36.00-26.50	3	
08488	MSD41301*	14.00-36.00-26.50	3	
08488	MT225-1301*	14.00-36.00-26.50	3	
08491	60200300*	14.50-30.00-21.50	3	
08491	MP440-2301*	14.50-30.00-21.50	3	
08482	+	14.50-30.00-21.50	3	
08493	60201944*	15.00-30.00-26.00	3	
08493	MP4110-1301*	15.00-30.00-26.00	3	
08483	+	15.00-30.00-26.00	3	
08495	60200946*	15.00-40.00-26.00	4	
08495	MP7100-1301*	15.00-40.00-26.00	4	
08495	MT475-1301*	15.00-40.00-26.00	4	
08495	MT475-2301*	15.00-40.00-26.00	4	
08486	+	15.00-40.00-26.00	4	
08499	60200987+	15.00-40.00-28.00	4	
08499	MT490-1301+	15.00-40.00-28.00	4	
08501	602011027+	15.00-40.00-28.00	4	
08501	MT490-3301+	15.00-40.00-28.00	4	
08503	MT7100-1301+	16.00-24.00-35.00	3	



CODICE PEDOL	CODICE ORIGINALE	DIMENSIONI T x A x R	POS.	DISEGNI DI RIFERIMENTO
08504	+	08.00-20.00-22.50	1	
08552		08.00-30.00-25.00	1	
08505	*	09.92-15.87-25.40	2	
08506	14525-11242*	10.00-16.00-28.00	3	
08487	14525-11242+	10.00-16.00-28.00	3	
08507	14334-10321*	10.00-25.00-27.00	4	
08508	14334-10322*	10.00-25.00-27.00	5	
08489	14334-10322+	10.00-25.00-27.00	5	
08509	14352-21222*	10.00-30.00-27.00	6	
08490	14352-21222+	10.00-30.00-27.00	6	
08510	79132-10212*	10.00-40.00-27.00	6	
08511	14152-11241*	12.35-40.00-34.00	7	
08512	14515-11590*	12.50-20.00-27.00	8	
08492	14515-11590+	12.50-20.00-27.00	8	
08513	14336-10331*	12.50-40.00-25.40	9	
08513	14336-10332*	12.50-40.00-25.40	9	
08515	14129-10332*	12.50-40.00-25.40	10	
08518	*	12.50-40.00-25.50	11	
08496	+	12.50-40.00-25.50	11	
08516	14324-11340+	12.50-40.00-27.00	12	
08517	14325-20391*	12.50-40.00-32.00	13	
08494	14325-20391+	12.50-40.00-32.00	13	
08519	*	12.50-40.00-32.50	14	
08497	+	12.50-40.00-32.50	14	
08520	14324-21400*	12.50-40.00-34.00	15	
08498	14324-21400+	12.50-40.00-34.00	15	
08521	14113-10850*	14.00-40.00-26.50	16	
08521	14113-11200*	14.00-40.00-26.50	16	
08521	14113-10850*	14.00-40.00-26.50	16	
08524	*	14.00-40.00-26.50	17	
08500	+	14.00-40.00-26.50	16	
08525	*	14.00-40.00-27.00	18	
08526	14176-11170+	14.00-40.00-27.00	19	
08527	14211-11170*	14.00-40.00-27.00	20	
08502	+	14.00-40.00-27.00	18	
08528	14326-31560*	14.00-40.00-34.00	18	
08514	14326-31560+	14.00-40.00-34.00	18	
08529	14124-21400*	16.00-40.00-34.00	15	

CODICE PEDOL	CODICE ORIGINALE	DIMENSIONI T x A x R	POS.	DISEGNI DI RIFERIMENTO
--------------	------------------	----------------------	------	------------------------

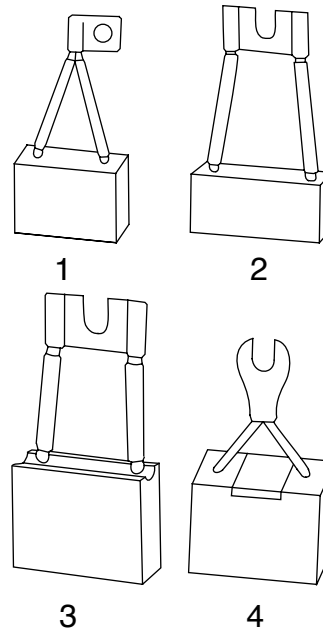
08530	1009599-008+	09.52-31.75-27.00	1	
08531	1045330-004+	09.52-38.10-22.20	2	
08532	1045313-004+	10.00-40.00-46.00	3	
08533	1049669-004+	16.00-40.00-40.00	4	

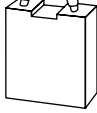
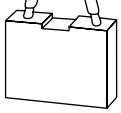
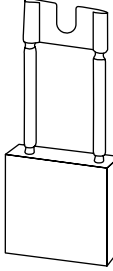
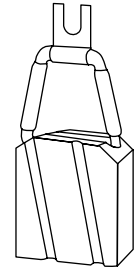
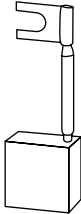
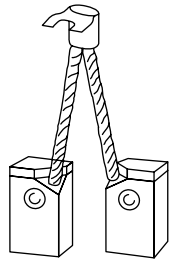
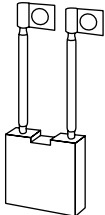
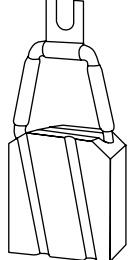

CODICE PEDOL	CODICE ORIGINALE	DIMENSIONI T x A x R	POS.	DISEGNI DI RIFERIMENTO
08534	013524+	06.00-16.00-22.10	1	
08535	013602*	06.00-28.00-30.50	2	
08536	010841*	06.00-28.00-30.50	3	
08523	013602+	06.00-28.00-30.50	2	
08543	010841+	06.00-28.00-30.50	3	
08537	010848*	06.40-08.00-16.00	4	
08538	010829*	07.00-16.00-22.00	5	
08539	013480+	08.00-16.00-22.10	1	
08540	011618+	08.00-20.00-23.20	6	
08541	010007*	08.00-28.00-30.50	3	
08542	013482+	08.00-28.00-30.50	7	
08542	013623+	08.00-28.00-30.50	7	
08544	013445*	08.00-28.00-30.50	8	
08549	010007+	08.00-28.00-30.50	3	
15086	013445+	08.00-28.00-30.50	8	
08545	010847*	08.00-32.00-31.00	9	
15087	010847+	08.00-32.00-31.00	9	
08546	013528+	08.00-32.00-32.00	10	
08547	014196*	08.00-32.00-32.00	11	
15088	014196+	08.00-32.00-32.00	11	
08548	011616*	09.00-13.00-25.50	12	
08548	018091*	09.00-13.00-25.50	12	
08550	010833*	09.00-20.00-27.00	13	
08560	013529*	10.00-16.00-31.00	14	
08561	013455*	10.00-16.00-31.00	15	
15089	013529+	10.00-16.00-31.00	14	
15090	013455+	10.00-16.00-31.00	15	
08563	010873*	10.00-26.00-31.00	8	

CODICE PEDOL	CODICE ORIGINALE	DIMENSIONI T x A x R	POS.	DISEGNI DI RIFERIMENTO	
08562	010837*	10.00-26.00-30.50	1		
15091	010837+	10.00-26.00-30.50	1		
08564	011611+	10.00-28.00-30.50	2		
08565	013479+	10.00-32.00-32.20	3		
08566	013479+	10.00-32.00-40.00	4		
08567	011617*	12.50-16.00-25.00	5		
08568	011621*	12.50-16.00-25.00	6		
08569	013447*	12.50-32.00-32.00	7		
15092	013447+	12.50-32.00-32.00	7	1	2
08570	013490+	12.50-32.00-40.00	8		
08571	013499+	16.00-32.00-40.00	8		
08560	013499*	16.00-32.00-40.00	8		
				3	4
					
				5	6
					
				7	8

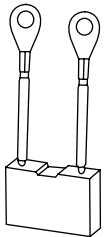
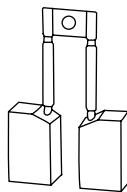
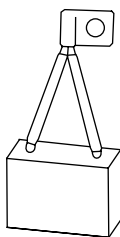
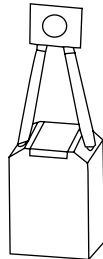
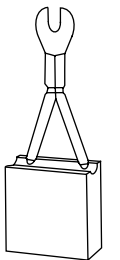
CODICE PEDOL	CODICE ORIGINALE	DIMENSIONI T x A x R	POS.	DISEGNI DI RIFERIMENTO
08572	2952999000*	06.30-27.00-19.00	1	
15093	2952999000+	06.30-27.00-19.00	1	
08573	*	06.35-26.98-20.00	1	
08574	*	10.00-12.50-23.50	2	
08575	+	11.11-25.40-25.40	3	
08576	296309400+	12.50-32.00-30.50	3	
08577	+	12.50-32.00-44.50	4	
08578	+	12.70-25.40-31.75	5	
08579	252356900+	12.70-53.50-44.50	6	
08580	+	16.00-40.00-45.00	7	
08581	+	20.00-25.00-43.00	7	